

Medium and High Density Property Development Structures

**Andreones Professional
Development Program**

9 June 2006

Gary Bugden

www.garybugden.com

Topics

- Background to higher density development
- The big picture objectives
- Community title structures
- Airspace subdivisions
- Available legal mechanisms
- Main problem area – the basement
- Structuring objectives
- Structuring principles
- Management of the legal process
- Staged developments
- Building management statements

Background to higher density development

- Public policy trends –
 - Higher densities
 - Mixed uses
- Commercial trends –
 - Larger developments
 - More complex developments
- Title, subdivision and management structuring is a critical exercise

The big picture objectives

- Create a harmonious management environment
 - Approach to subdivision and titling
 - Choice of management structures
 - Allocation of maintenance responsibility
- Enhance the value of commercial components

Community Title Structures

- Single use – not staged
- Single use –staged
- Mixed use – staged
- Two tier structure
- Three tier structure

Single Use – Not Staged

Subdivision

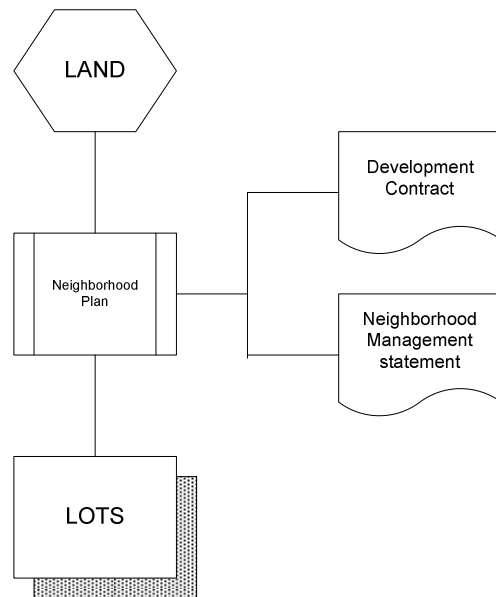

Single Use – Not staged

Subdivision

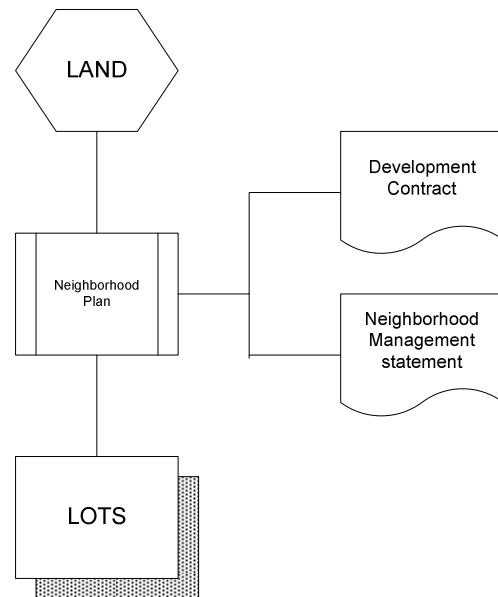

Management

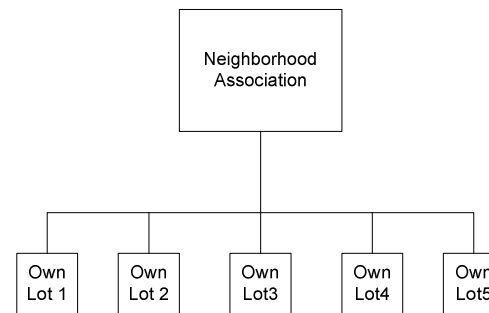

Single Use - Staged

Subdivision

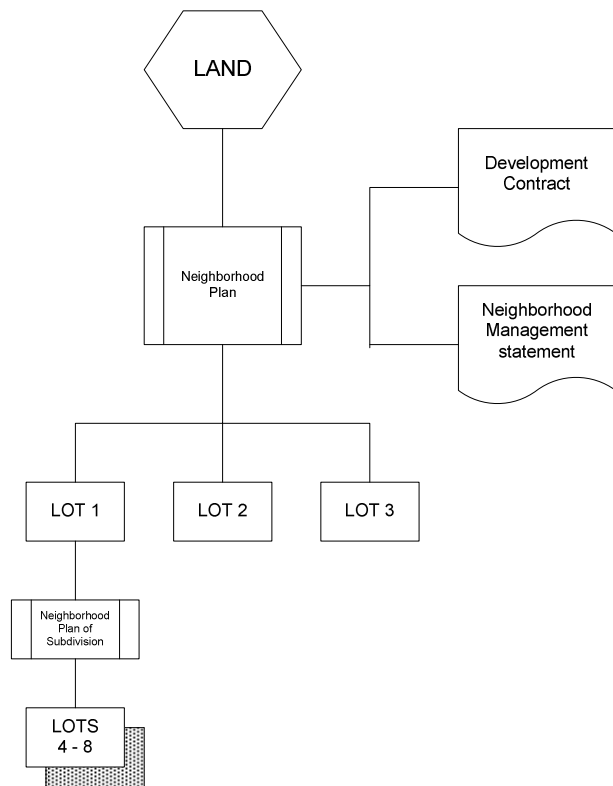

Single Use - Staged

Subdivision

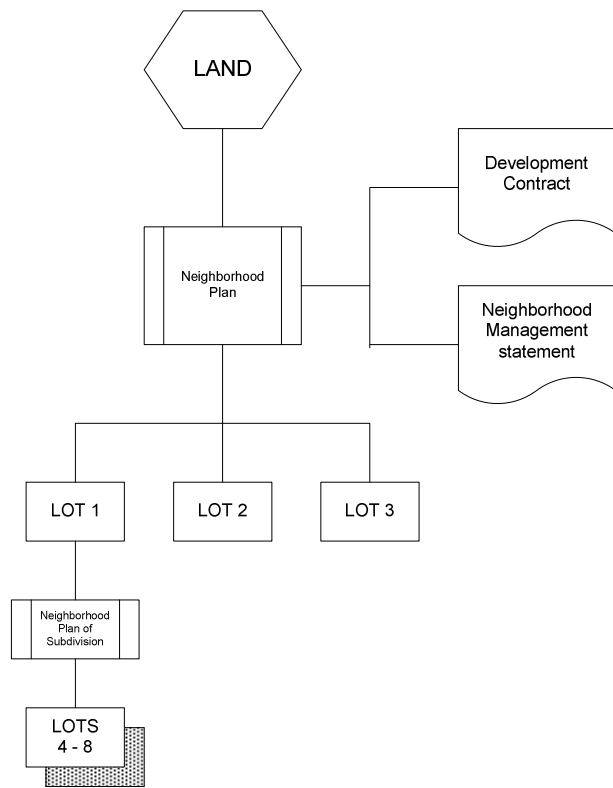

Management

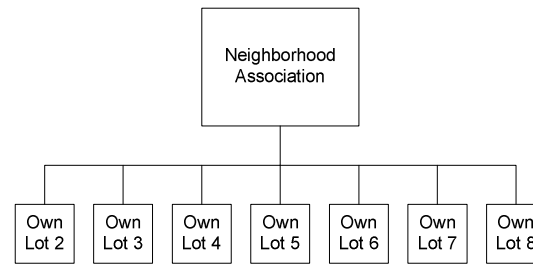

Two Tier Structure

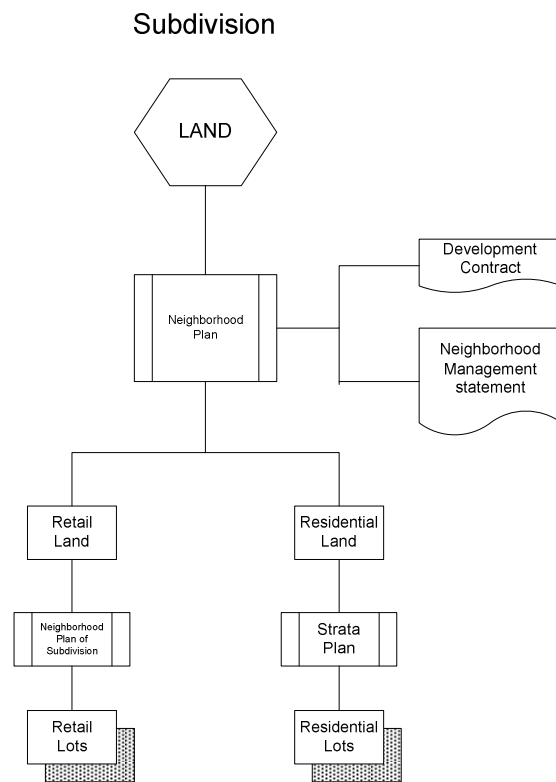

Two Tier Structure

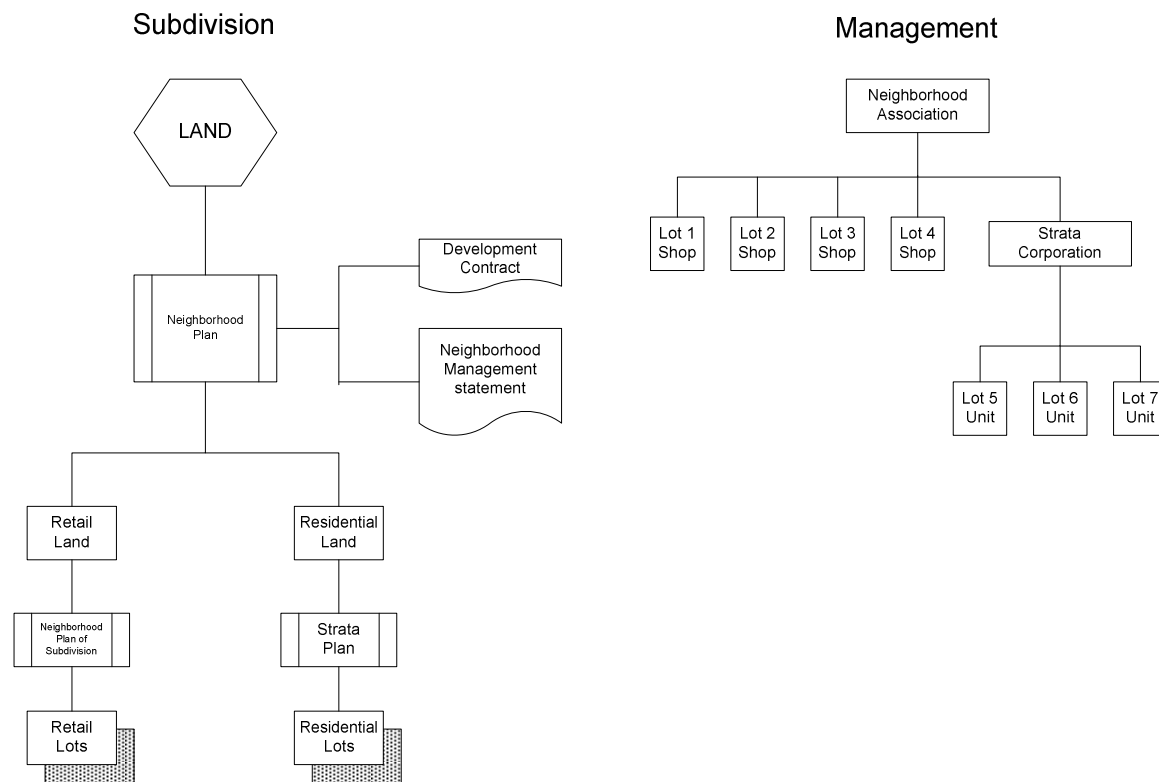

Three Tier Structure

Subdivision

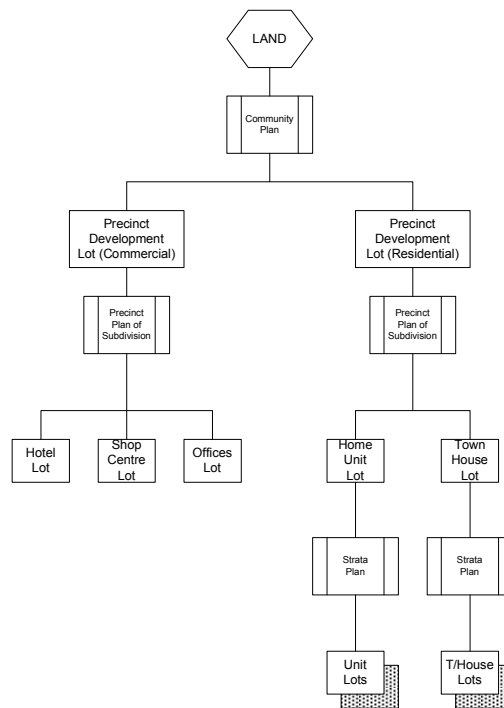

Copyright: G F Bugden

Three Tier Structure

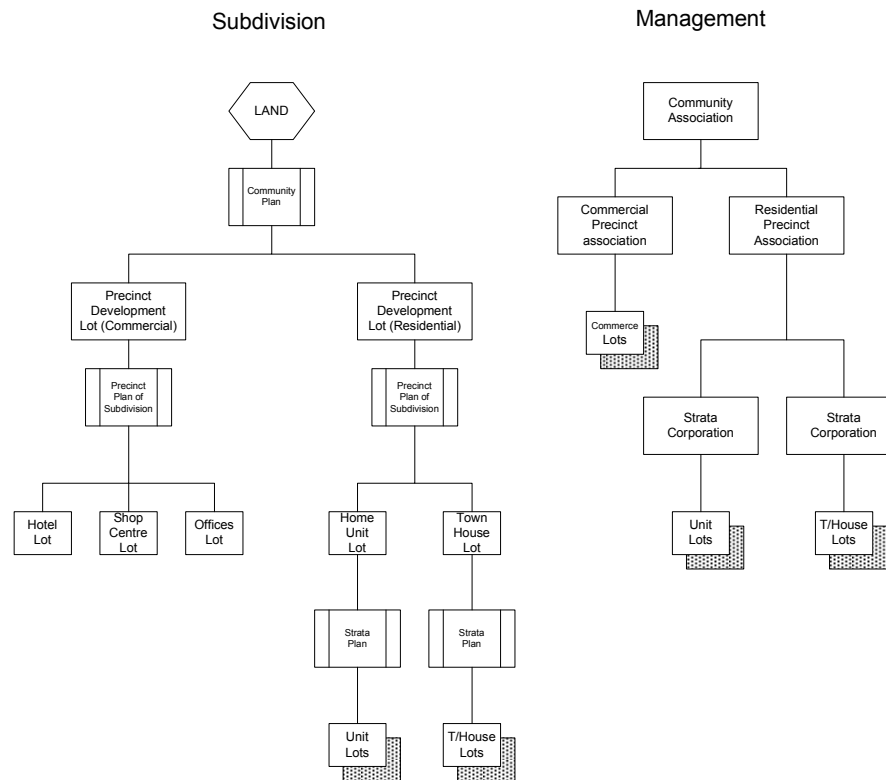

Airspace subdivisions

- Airspace/stratum/volumetric
- Subdivision of land above and/or below the ground's surface
- Start – conventional Torrens title surface lot
- Subdivide that lot
- New lots –
 - are limited in height and depth
 - usually comprise a series of cubic spaces
 - usually relate to part of a building

Example

- Redevelopment of large site
- Development comprises –
 - Shared underground basement car park
 - Shopping centre between basement and podium
 - Hotel tower above podium
 - Residential tower above podium
- Residential tower to be strata subdivided
- Shopping centre and hotel to be separate non-strata lots

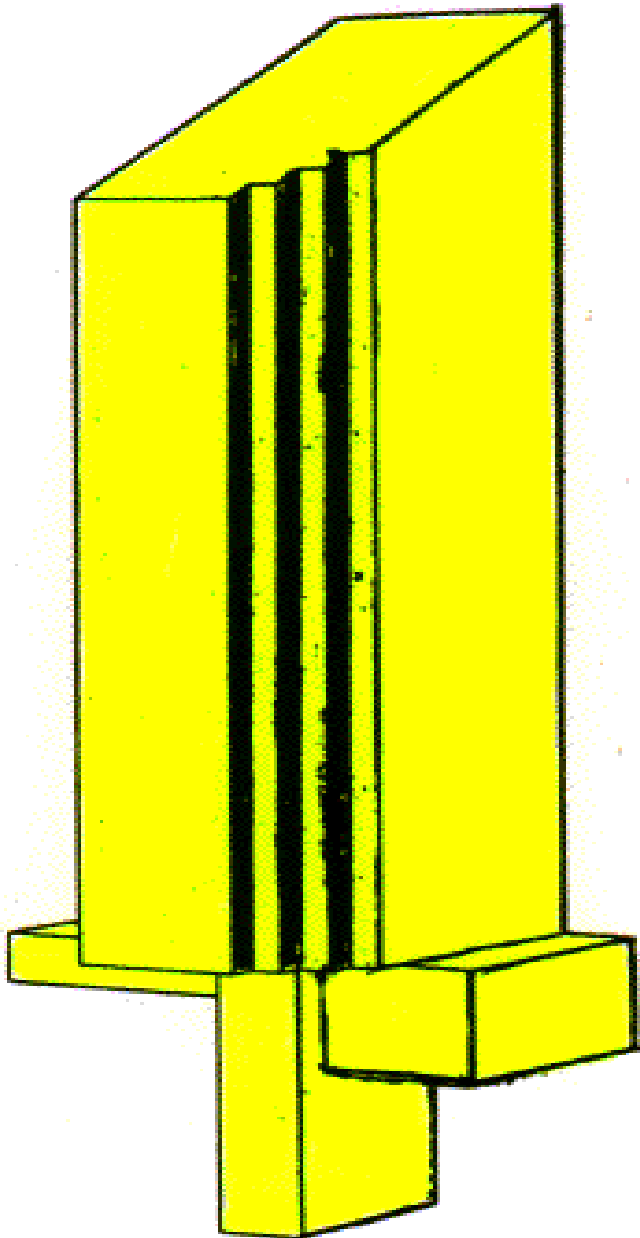

Tower & Plug

Plug Hole in Podium Levels

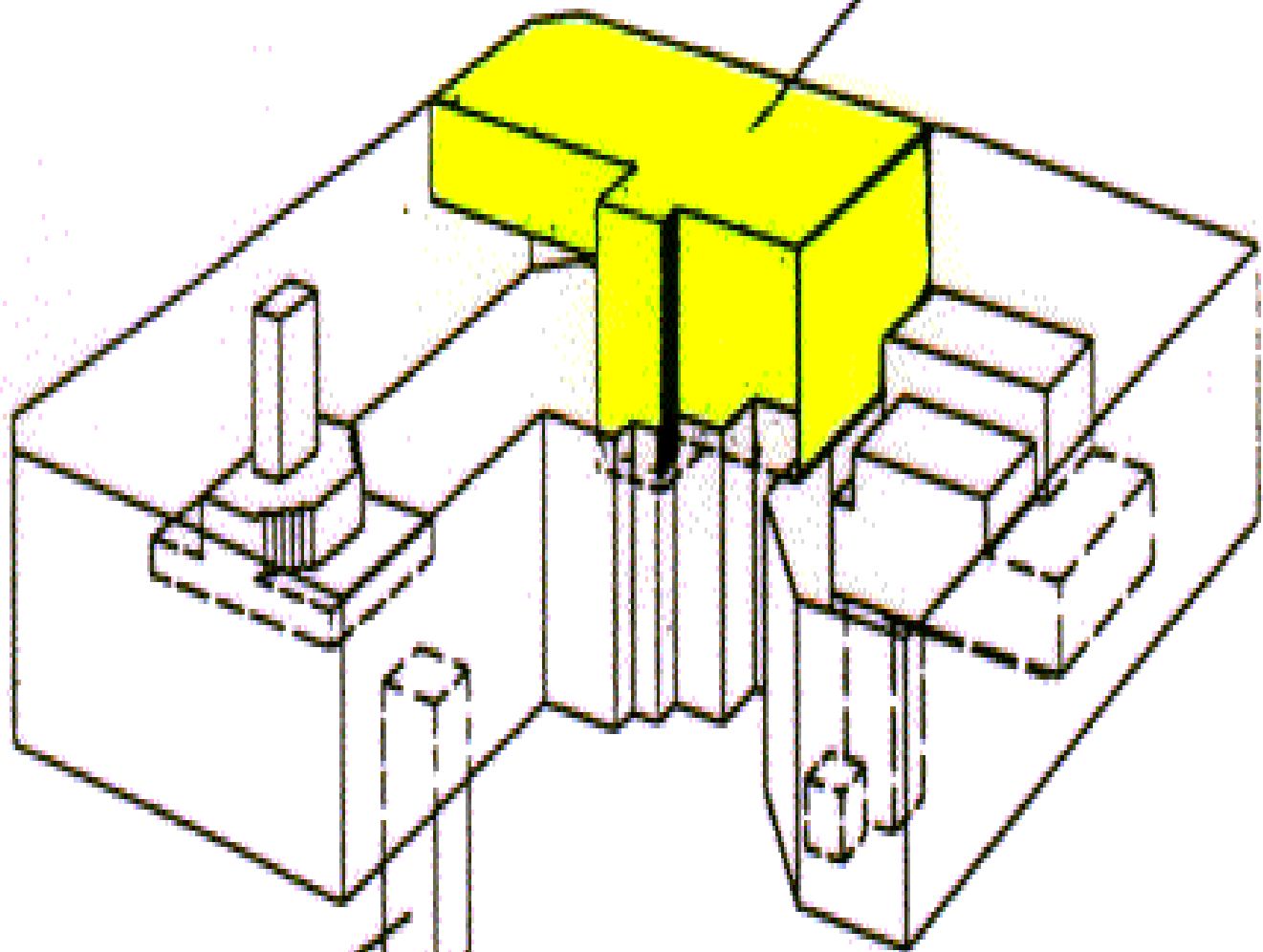

Podium lift 2 plug



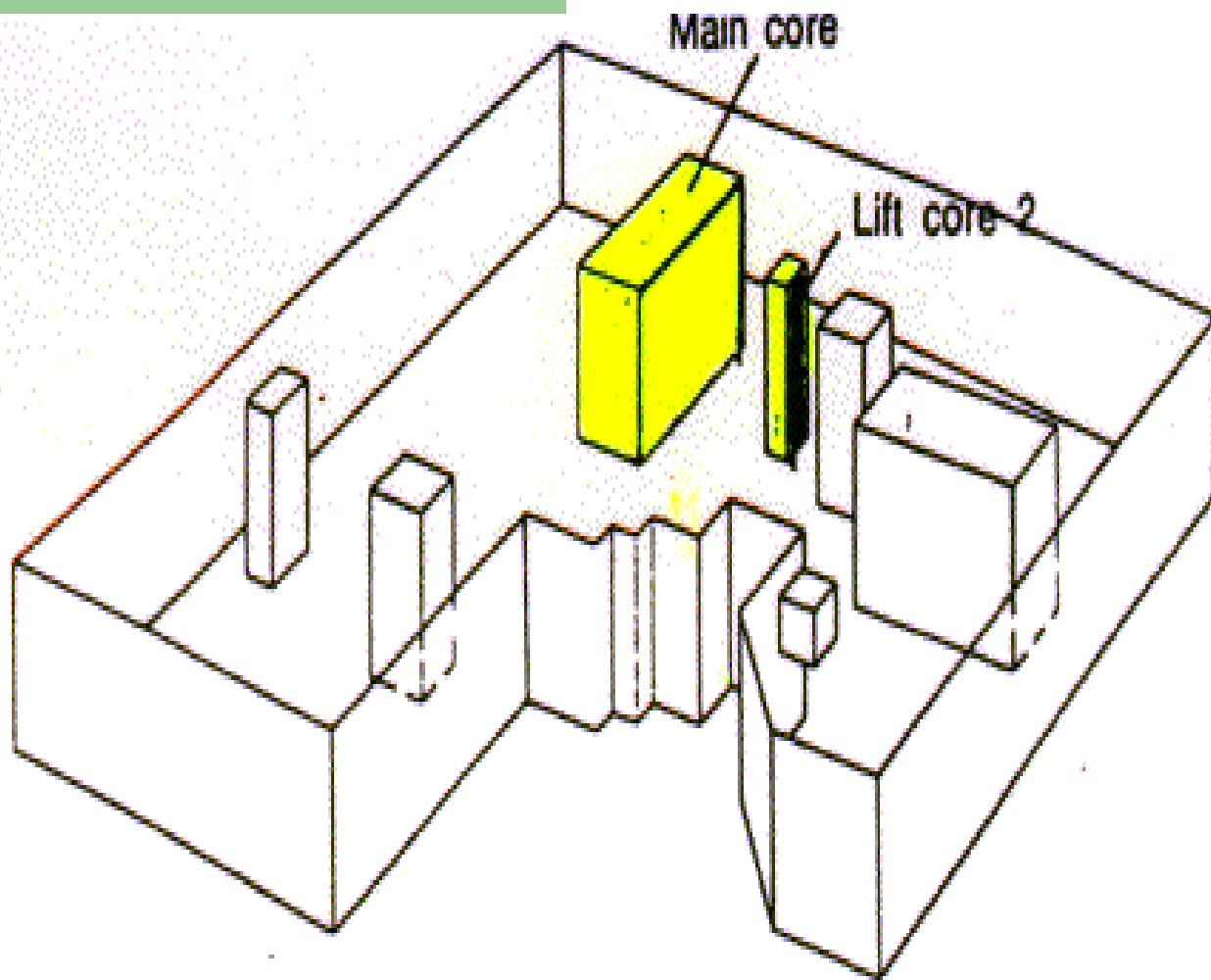

Plug Holes in
Basement Levels



Available legal mechanisms

- Stratum subdivisions
- Strata management statements
- Building management statements
- Easements
- Inter-body corporate agreements
- Development covenants/public positive covenants
- Umbrella agreements

Main problem area – The basement

Reasons why it is a problem -

- Separate parking areas required for various components
- Common driveways
- Houses most equipment
- Houses wide range of services
- Houses loading dock and garbage facilities
- Security is important
- Day to day operation is complex
- Houses shared fire safety mechanisms

Structuring objectives

- Ensure fair and sensible arrangements
- Maximise marketability of commercial areas
- Separate decision making
- Create harmonious management environment
- Allow maximum flexibility for developer
- Protect developer control in staged developments

Structuring principles

- Design solutions are best
- Separately service each component use area
- Arrange services together
- Keep equipment and facilities under footprint
- Or – keep in clusters close to footprint
- Location determines ownership

Structuring principles (continued)

- Use determines maintenance responsibility
- Estimate use during design and construction
- Minimise number of bodies corporate
- Keep local government in the loop
- Regularly consult Titles Office

Management of the legal process

- Ensure project manager appreciates importance
- Plan title subdivision and management structure early
- Meet with consultants early in planning process
- Prepare and distribute a consultant's brief
- Monitor progress – regular meetings
- Prepare update and distribute legal program
- Prepare update and distribute legal checklists
- Draft and distribute documents early
- Use web site as a repository

More Complex Example

King Street Wharf

Darling Harbour

DARLING HARBOUR 9 & 10 Development Parcels

Fig.5

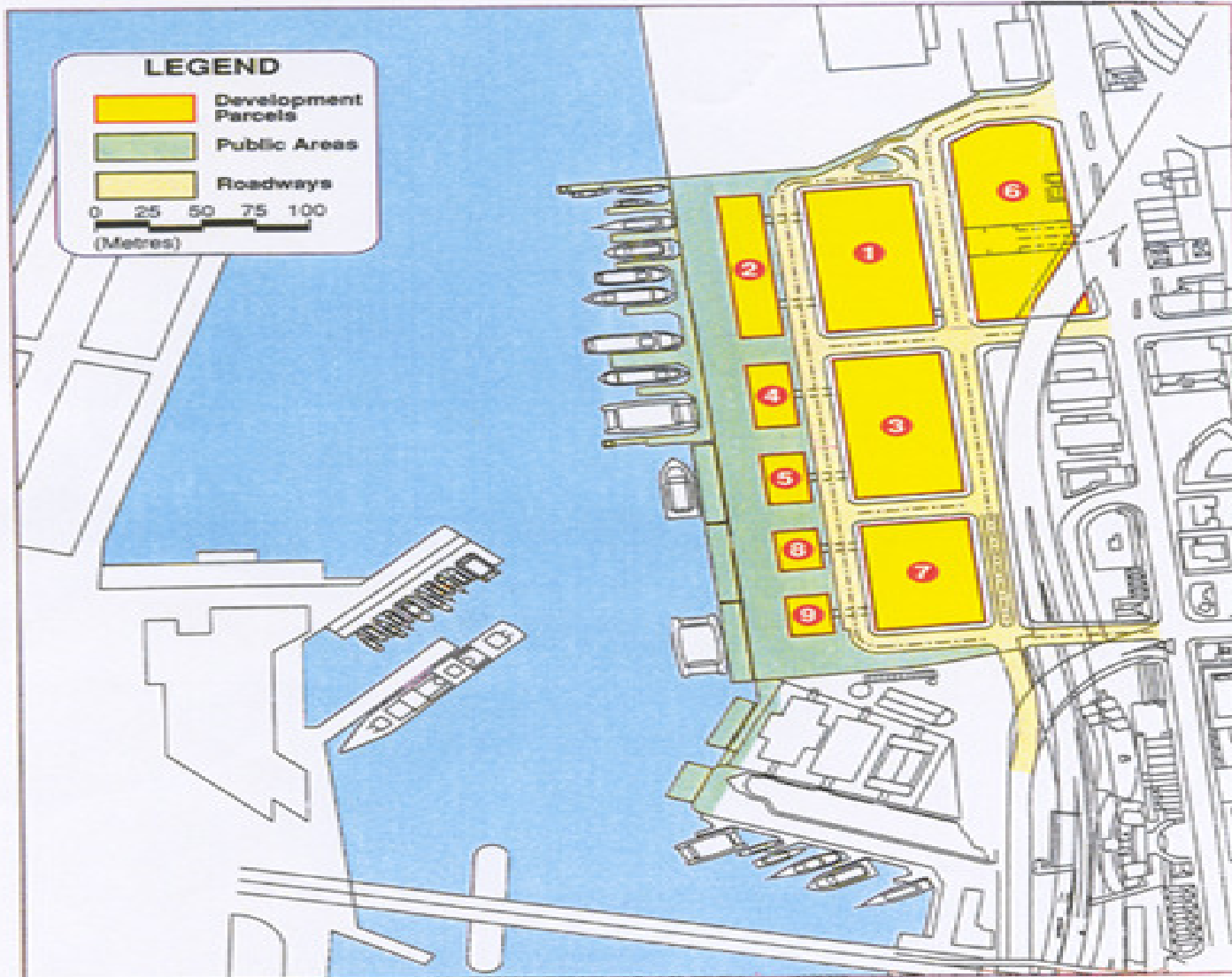

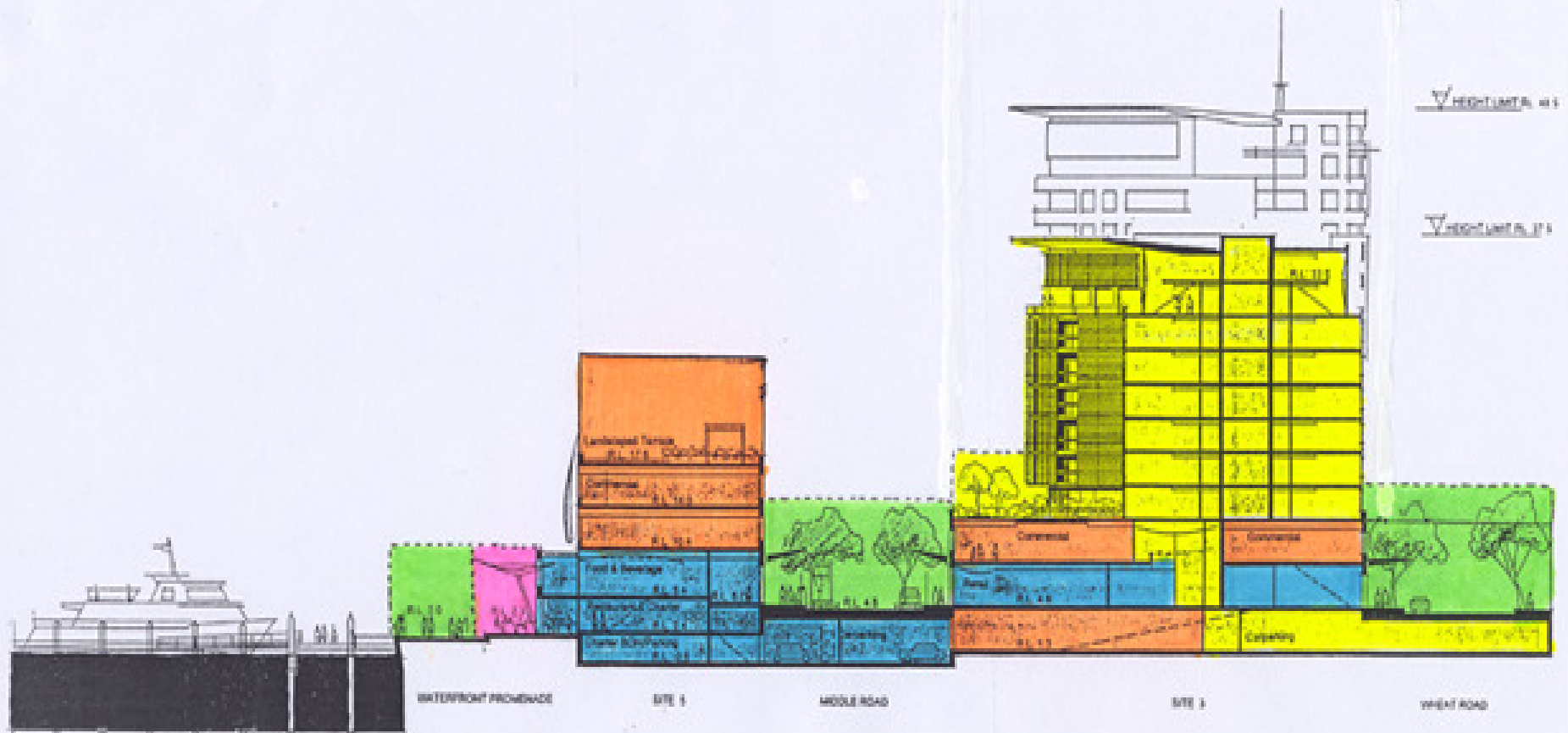

MIDDLE SECTION

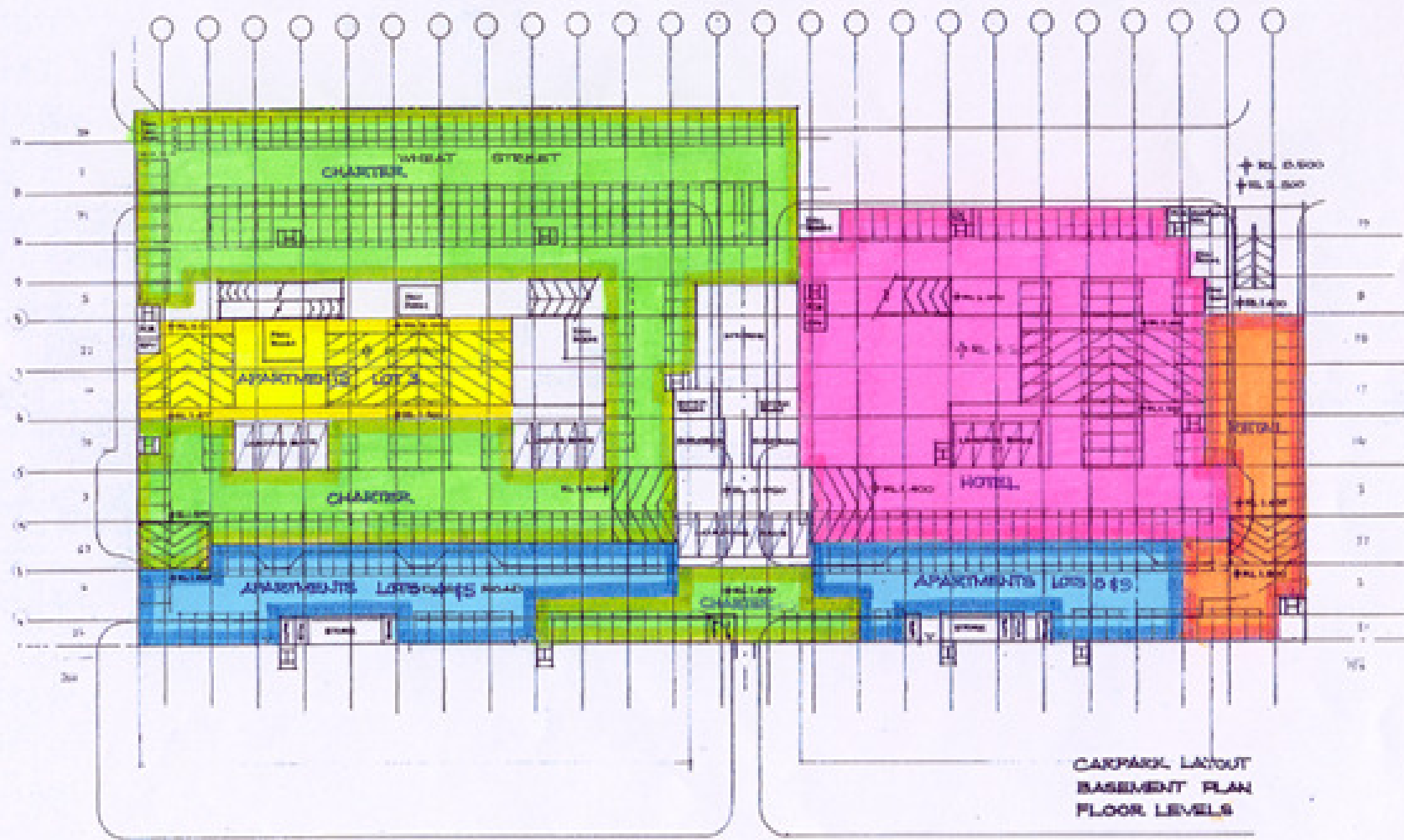

Staged development

- Well defined staging program and management structure
- Full disclosure
- Reserve right to make changes
- Bind purchasers to tolerate construction activity
- Build in exit strategy

Staged development (continued)

- Prepare explanatory material
- Capture voting rights
- Use a development deed to bind the body corporate
- Identify constraints in the legislation
- Ensure developer understands risk

Queensland tiered body corporate structures

- Used to separate commercial and non-commercial components
- Administrative responsibility is allocated among bodies corporate

Two-tier structure

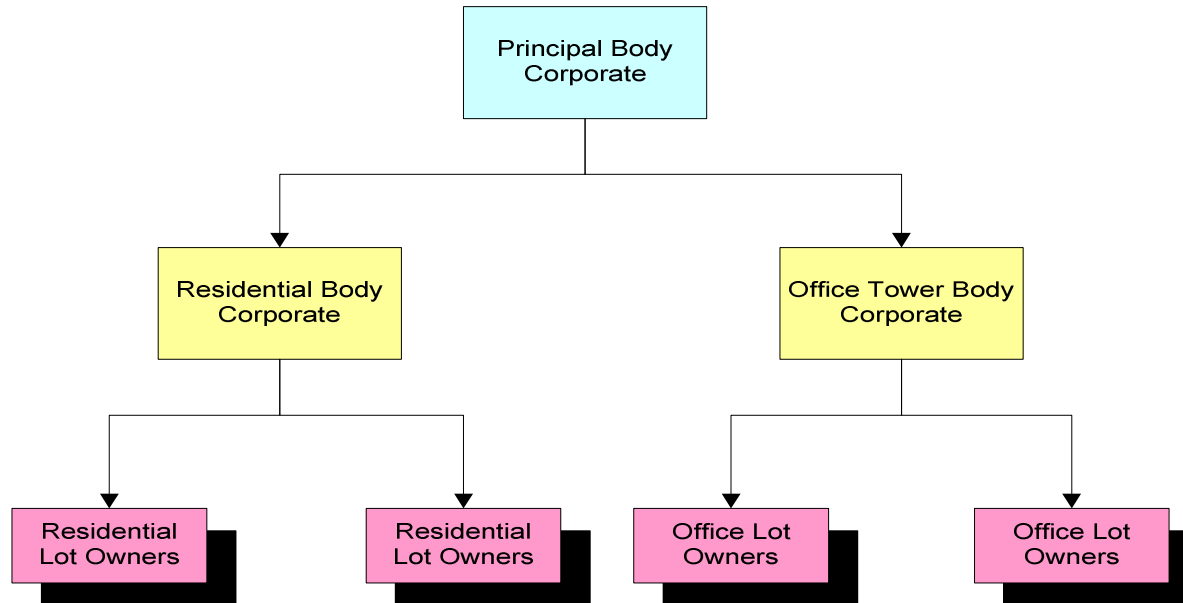

Alternate two-tier structure

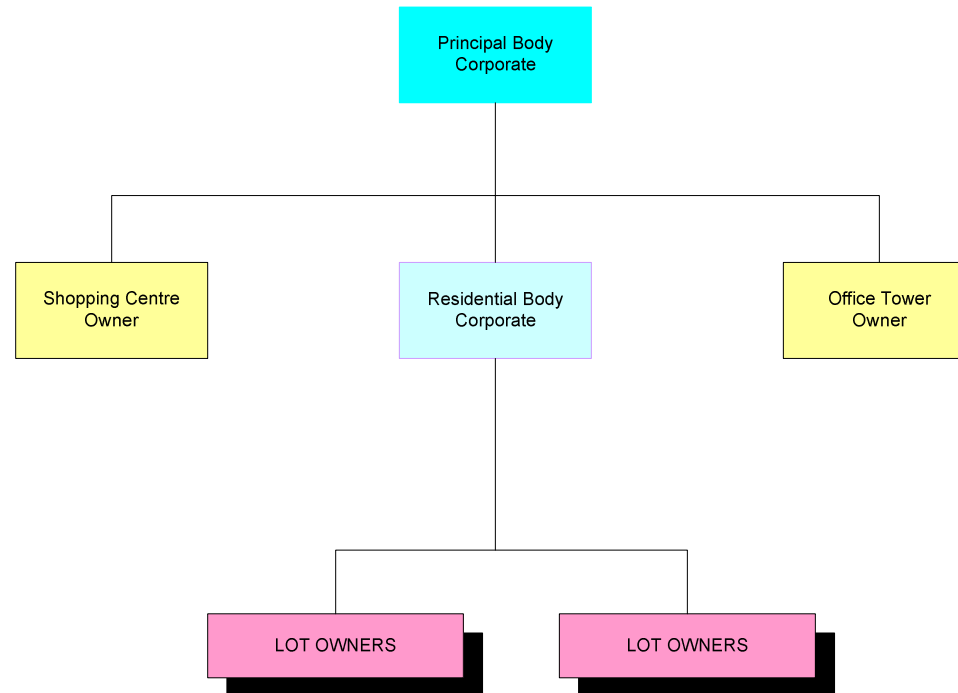

Building Management Statements

- Mechanism in *Conveyancing Act*
- Intended for use where no strata subdivision and no Strata Management statement
- Provide means to manage separate mixed use areas sharing common services, facilities and equipment

Building Management Statements

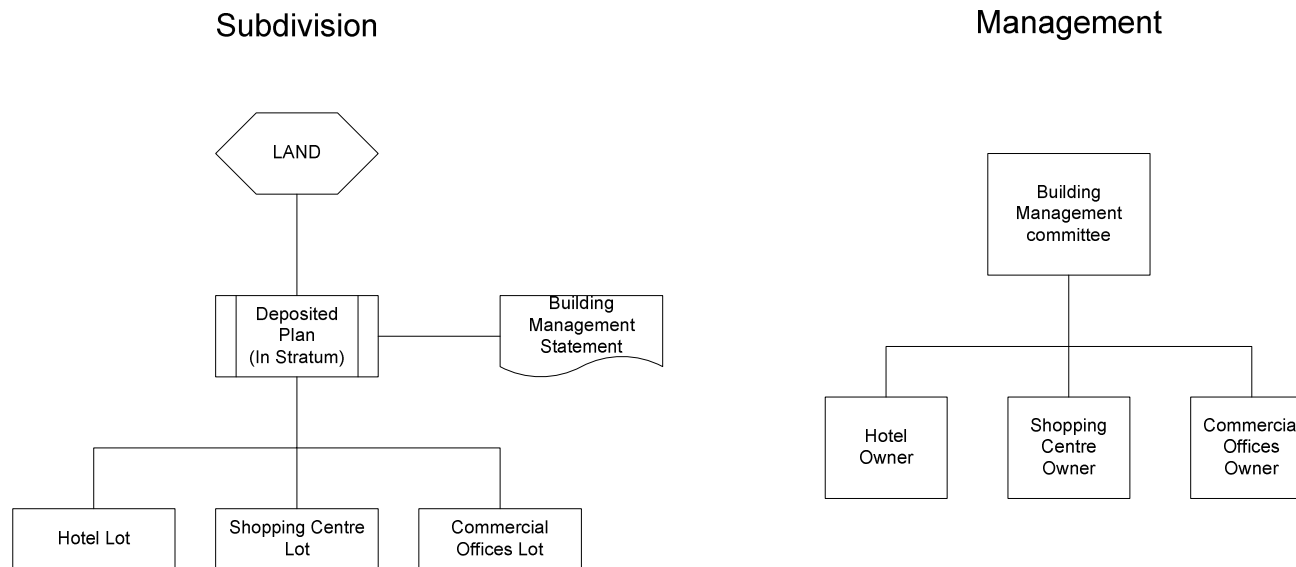

Summary

What multi-use projects require

- Thorough understanding of legislation
- Careful planning
- Understanding of available legal mechanisms
- Understanding of structuring objectives
- Application of structuring principles
- Full disclosure and clear explanations
- Competent team of consultants
- Teamwork
- Consultation with local government + agencies
- Management of the legal process

Medium and High Density Property Development Structures

**Andreones Professional
Development Program**

9 June 2006

Gary Bugden

www.garybugden.com